



MAX CHARGE MC-612-DUAL

MULTI-STAGE VOLTAGE REGULATOR

INSTALLATION AND OPERATION MANUAL

Introduction

The Balmar Max Charge MC-612-DUAL is designed for use in single engine / dual alternator applications where both alternators are being used to charge the same large battery bank.

The MC-612-DUAL provides two field output connectors, two power input connectors and two system ground connections, making it possible to use two standard wiring harnesses when connecting to two alternators.

The MC-612-DUAL features user selectable programs for the following battery types: Deep cycle flooded, standard flooded, gel, AGM, spiral wound AGM, and LiFePO₄ batteries. The regulator also features a universal default program that's designed for use in vessels utilizing voltage sensitive halogen equipment.

When used in conjunction with optional alternator and battery temperature sensors, the MC-612-DUAL has the ability to monitor temperatures and respond by increasing or decreasing voltage output to adapt to conditions. By selecting the setting that best suits the application, the user can provide sensing at two alternators and one battery bank or one alternator and two battery banks. To take the best advantage of the MC-612-DUAL and its features, please take the time to read this manual.

Table of Contents

Introduction	1	Basic Programming	10
Safety Considerations	1	Adjust For Battery Type	10
Regulator Installation	2	LiFePO ₄	11
Unpacking Box	2	Belt Load Manager	12
Locate/Mount Regulator	2	Display Mode	12
Basic Wiring Installation	2	Alt. Failure Advisory	12
Regulator Terminal Layout	3	Programming Flow Chart	13
Installation By Wire	4-6	Adv. Programming	14-15
Initial Start Up	6	Battery Equalization	16
Regulator Operation	7	Default Program Settings	16
Programming Display Modes	8	Add'l. Regulator Features	16
Regulator Programming	10	Troubleshooting	17-18
Using Magnetic Tool	10	Warranty	19

Safety Considerations

1. Always disconnect your battery banks and ensure that switches are "OFF" prior to installing your regulator.
2. Remove loose-fitting clothing or jewelry, which could become entangled in your motor or other machinery prior to installing regulator.
3. Wear ANSI-approved safety eye-wear and protective gear.
4. DO NOT attempt to modify the regulator. Modifications could result in damage to your charging system, and will void your warranty.
5. DO NOT attempt installation if you are tired or fatigued.
6. Ensure that the engine has cooled before initiating installation.
7. DO NOT attempt regulator installation while using alcohol or medication that could impair your judgment or reaction time.
8. Always use the right tool for the job. Improper tool use may damage regulator or your vessel, and could result in personal injury.
9. Take time to read the manual. Equipment damage and possible injuries may result from an incomplete understanding of the installation and operation of the MC-612-DUAL regulator. If you are unfamiliar with marine electrical systems, consult with a licensed marine electrician.

CAUTION: The following instructions are intended for use by experienced marine electrical installers. If you are not experienced at installing electrical system components, we recommend the use of a qualified marine electrical technician.

Regulator Installation

The following information is intended to provide the installer with the basic information required to complete installation. This section of the installation manual will deal with mounting, wiring connections and basic programming for battery type. Additional information regarding advanced programming adjustments and troubleshooting are addressed later in the manual.

Unpacking the Box

Your Max Charge MC-612-DUAL-H regulator kit is packaged with the following items:

- Max Charge MC-12-DUAL Regulator
- (2) 54" Wiring Harness
- Fused (1A) Battery Sense Wire Pigtail
- Magnetic Programming Tool
- MC-612-DUAL Quick Start Guide

If any of the listed items is not included with your regulator kit, call our customer service department at 360-435-6100. Please note - If your regulator box is marked Max Charge MC-612-DUAL, without the "H" designation your kit will not include the wiring harness or fused battery sense pigtail.



Locate And Mount The Regulator

Choosing a mounting location for your voltage regulator should be determined based on the following factors; distance from alternator, distance from inverters, transmitters and other sources of RF noise, convenient access and readability of the display. *Note: The regulator or harness should not be mounted close to large battery cables.* The regulator wiring harness is 54 inches long, providing a three to four foot radius for mounting. Ample airflow is essential for the regulator's proper operation. Ensure that the regulator is free from obstructions that restrict air movement around or below the regulator's aluminum heat sink. While the regulator is designed to operate safely in conditions typical of a marine engine compartment, the regulator may be better protected, and easier to use and monitor if mounted outside of the engine compartment. The max operating temperature is 90°C.

Should it be necessary to install the regulator further than 54" from the alternator, ensure that any wire extensions are properly connected, as resistance in the harness wiring can affect charging efficiency. If harness length must reach beyond approximately 8', replace the RED power and BLUE field wires with larger gauge wire that's sized to ensure voltage drop < 3%.

Basic Wiring Installation

The regulator's wiring harness includes six wires required for standard installation. Four of those wires are connected to the regulator via a Ford-style plug connector that's pre-installed on the regulator. These wires include the Ground (BLACK), Power (RED), Ignition (BROWN), and Field (BLUE).

In addition, the harness includes a separate Stator (WHITE) wire. The proper terminal connection points for this, and additional wiring connections, are illustrated on the pin location legend shown and discussed on the following pages.

Battery Sense Wire?

The MC-612-DUAL is designed with parallel terminal locations for field, power and ground circuits, so two standard Balmar wiring harnesses can be used together.

MC-612-DUAL Regulator Terminal Layout

1. GROUND INPUT (ALTERNATOR #2)
2. GROUND INPUT (ALTERNATOR #1)
3. POWER INPUT (ALTERNATOR #2)
4. POWER INPUT (ALTERNATOR #1)
5. IGNITION INPUT (ALTERNATOR #1)
6. FIELD OUTPUT (ALTERNATOR #1)
7. FIELD OUTPUT (ALTERNATOR #2)
8. ALT. TEMP. #1 (-)
9. ALT. TEMP. #1 (+)
10. BAT. TEMP. #1 (-)
11. BAT. TEMP. #1 (+)
12. POSITIVE VOLTAGE SENSE
13. DATA RX
14. DATA TX
15. STATOR IN
16. TACHOMETER OUT
17. ALT. #2 / BAT. #2 TEMP. (-)
18. ALT. #2 / BAT.#2 TEMP. (+)
19. AUX. #1 LAMP
20. DASH LAMP

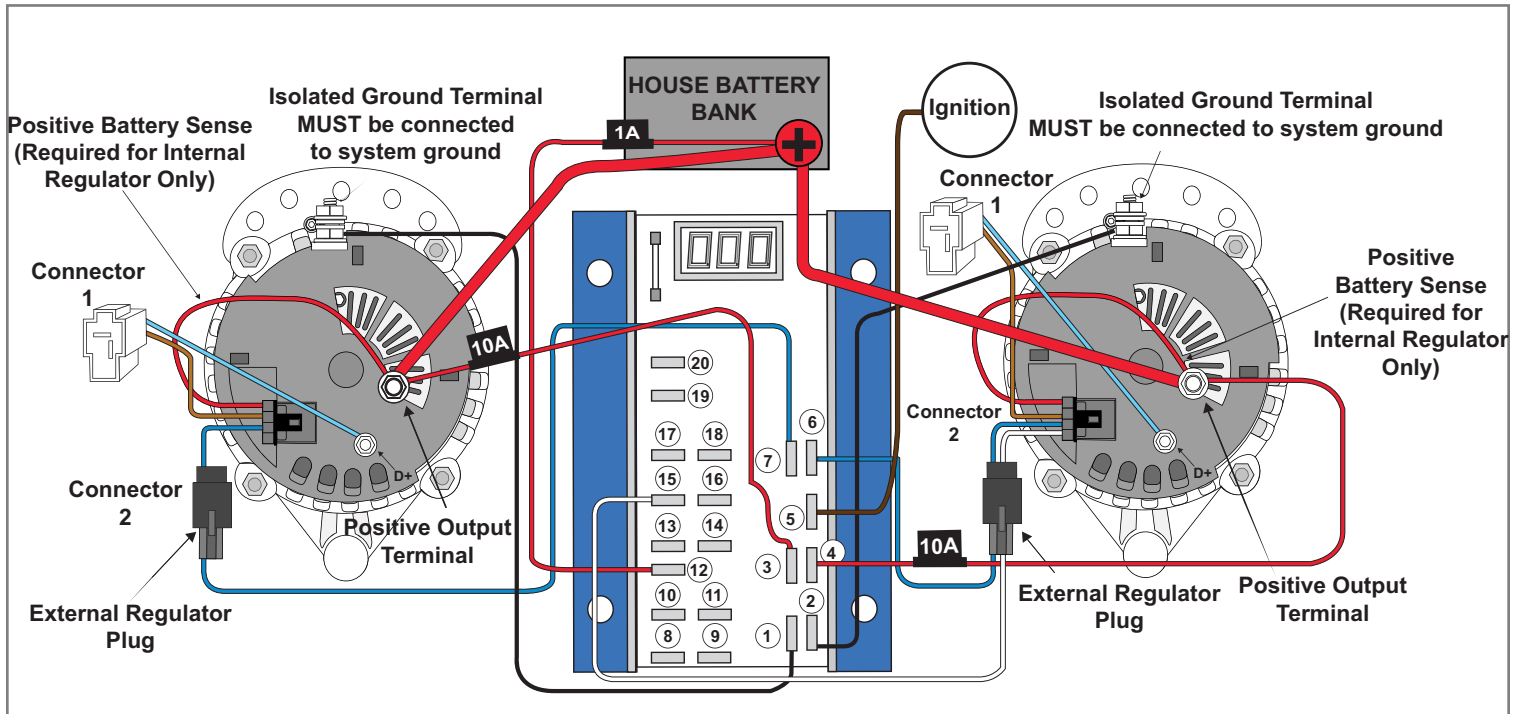
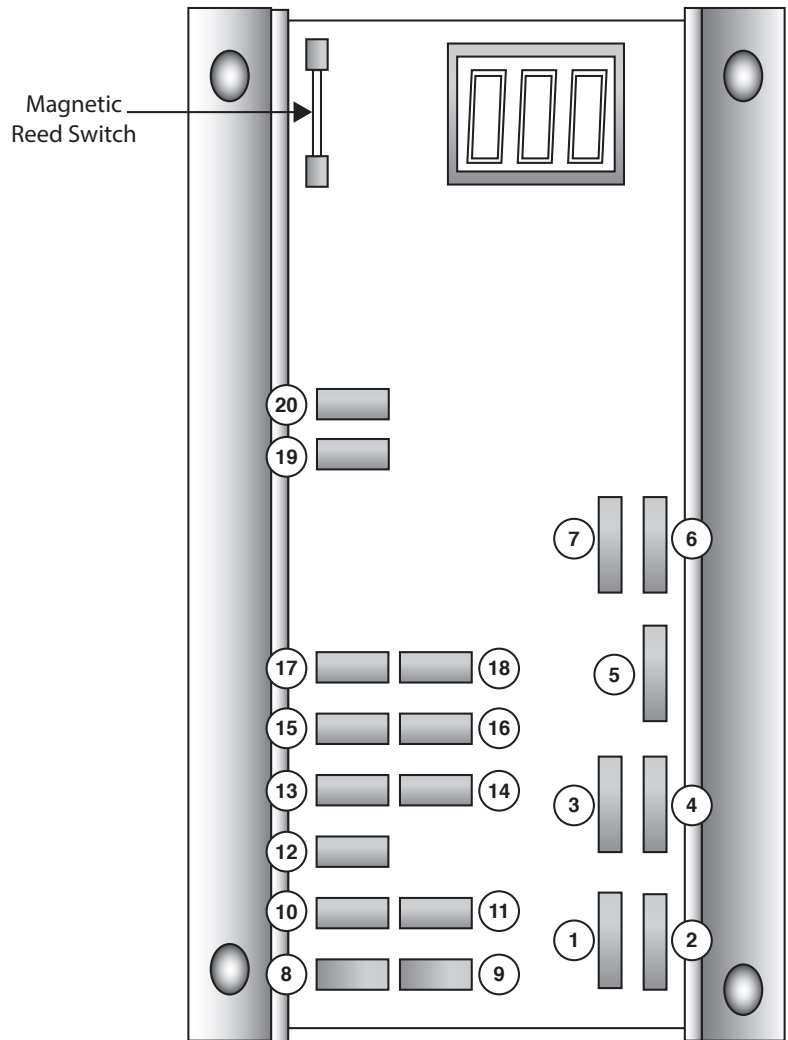

Installation by Wire

NOTE: Must install wires listed on this page for regulator to operate.

Install BLACK Ground Wire(s)

The BLACK Ground Wire (#1 and #2 in diagram at right) are included in the four-wire Ford-style plugs on both wiring harnesses and are factory installed on regulator packages designated with "H" at the end of the model number. The other end of the Ground Wire is fitted with a ring terminal connector. In most applications, this wire can be connected directly to the alternator's ground terminal post. For best accuracy ground as close to the battery as possible. Both the alternator(s) and regulator(s) must be connected to system ground. Check continuity between primary and secondary alternator ground terminals to ensure minimal resistance.

Install RED Power Wire(s)

The RED Power Wires (#3 and #4 in diagram at right) are included in the four-wire Ford-style plugs on the primary and secondary wiring harnesses and are factory installed on regulator packages designated with "H" at the end of the model number. The other end of the Power Wire is fitted with a ring terminal connector. In most applications, this wire can be connected directly to the alternator's positive output post. When a diode-type battery isolator is used, the primary and secondary power wires must be connected to the battery side of the battery isolator. Power Wires are equipped with 10-amp ATC type fusing. Primary and secondary wires must be fused.

Install BROWN Ignition Wire

The BROWN Ignition Wire (#5 in diagram at right) provides the ON/OFF voltage for the regulator. This wire is included in the Ford-style plug at the regulator end of the PRIMARY wiring harness. The other end of the wire is fitted with a butt connector.

Typically, the ignition wire is connected to the ON side of the ignition switch. This may be at the actual switch, or to the wire in the existing engine wiring loom that delivers switched voltage from the ignition switch. In some cases, an oil pressure switch may be used to activate the regulator. In either case, the regulator's ignition wire must see zero volts when the engine ignition is switched off. Only one ignition wire is required to activate the regulator.

Install BLUE Field Wire(s)

The BLUE Field Wires (#6 and #7 in diagram at right) provide regulated voltage to the alternators to excite the rotors and stators and control alternator output. The wires are included in the four-wire Ford-style plugs on the primary and secondary wiring harnesses and are factory installed on regulator packages designated with "H" at the end of the model number. The other end of the wire is terminated in a two prong plug for use with Balmar Alternators (For use with other alternators remove the plug). Attach the field wire to the alternator's field terminal. Field wires should be equal in length. See your alternator manual for any specific requirements your alternator may have.

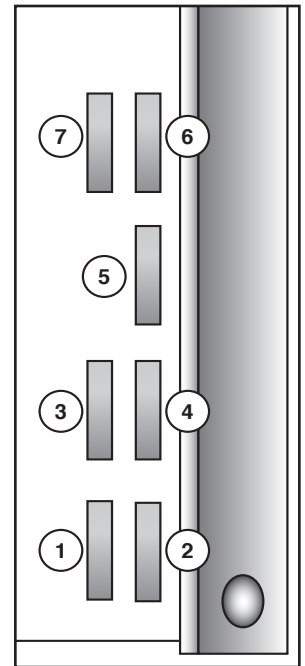

Install Positive Battery Sense Wire

Included with the MC-612-DUAL's wiring harness kit is a fused wiring pigtail which features a ring terminal at one end and a butt connector at the other. In the center is a 1-Amp ATC-type fuse and fuse holder. This wire must be connected at the #12 Positive Battery Sense terminal A female quick connect plug has been pre-attached on the terminal #12 pin. To complete installation of the sense circuit:

1. Identify the favored location for battery sensing. In most instances, the positive output of the alternator, the common side of a battery switch, or the positive post of the battery being charged will work best. If the batteries are connected to a battery isolator, the positive sense wire must be connected to the battery side of the isolator, preferably at the larger of the battery banks.
2. Attach the included wiring pigtail with 1-amp fuse to a length of wire of sufficient to reach from the regulator to the desired sensing location. If the length of the wire run between the regulator and the sensing location is 8' or less, a 16-gauge wire is satisfactory. If the wire run exceeds 8', increase the wire size to 14 gauge.
3. Remove the female 1/4" spade terminal from the terminal #12 pin. Crimp the spade terminal to the sense wire and reconnect the spade to the #12 terminal pin.

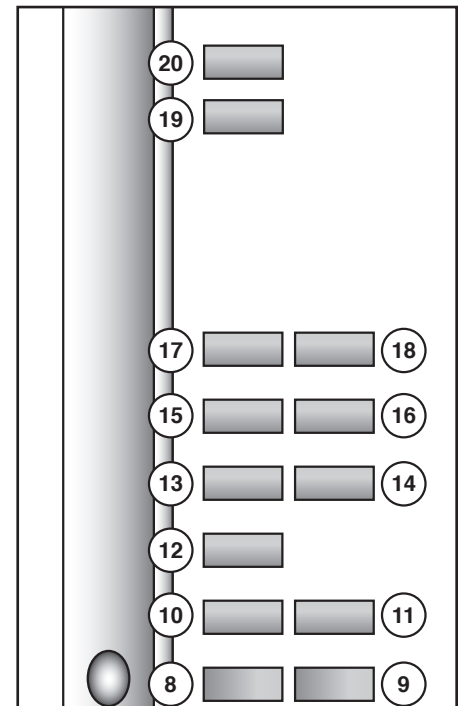

Install Alternator #1 Temperature Sensor

The optional Alternator Temperature Sensor (MC-TS-A) allows your MC-612-DUAL voltage regulator to monitor your alternator temperatures and limit output if safe operating levels are exceeded. The MC-612-DUAL uses active temperature regulation to maximize high-temperature output. The MC-TS-A sensor includes a 54" cable, a sensing attachment lug and positive and negative regulator plug-in connectors.

To install the MC-TS-A:

1. Connect the sensor lug to one of the four bolts that hold the alternator's front and rear cases together. If a Balmar alternator is installed use the predrilled location provided on the rear case. Extend sensor cable to the regulator. The cable can be included within the regulator's wiring harness, or can be run alongside the harness and attached with cable ties.
2. Connect the temperature sensor to the Alt. Temp. #1 terminals on the regulator. It is essential that the terminals are connected to the correct pin. Connect the red wire to the positive terminal #9 and the black wire to the negative terminal #8.

Install Battery #1 Temperature Sensor

The MC-TS-B optional Battery Temperature Sensor allows your Max Charge MC-612-DUAL voltage regulator to monitor your battery bank for changes in battery temperature, adjust charging voltages to compensate for battery temperature, and respond to a battery over-temperature condition by discontinuing charging. The MC-TS-B sensor includes a 20-foot cable, a sensing attachment lug and positive and negative regulator plug-in connectors.

To install the MC-TS-B:

1. Connect the sensor lug to the battery negative post closest to the center of the battery bank. Extend sensor cable to the regulator.
2. Connect the temperature sensor to the Bat. #1 Temp. terminals on the regulator. It is essential that the terminals are connected to the correct pin. Connect the red wire to the positive terminal #11 and the black wire to the negative terminal #10.

Data TX and RX Terminals (#13 and #14)

Are currently for factory use only, and are capped to protect against accidental connection.

Install WHITE Stator-In And Tach-Out Wires

The alternator's stator output provides the electrical pulse needed to drive the tachometer. The MC-612-DUAL provides regulated tach output when the WHITE stator wire is connected to the regulator's Stator In (#15 in diagram) terminal and the outfeed wire to the electric tachometer is connected to the Tach Out terminal (#16 in diagram).

Most Balmar alternators feature 12-pole rotors and stators, though, in some cases, the pole count may be 14. See alternator manual for specifics. See your tachometer manual for adjustment instructions.

Install Battery #2 / Alternator #2 Temperature Sensor

Your Max Charge MC-612-DUAL voltage regulator can accommodate either alternator or battery temperature sensing on terminals #17 and #18, depending on your preference. When controlling two alternators with the MC-612-DUAL, the use of a secondary alternator temperature sensor enables the regulator to respond to over-temperature conditions at the second alternator. Used in conjunction with an optional MC-TS-B battery temperature sensor, the regulator can monitor the temperature of a secondary battery bank, and respond to a battery over-temperature condition by discontinuing charging.

To install a secondary temperature sensor:

1. Select the optional sensor that best fits your application.
2. Connect the sensor lug to the secondary alternator or battery bank following the directions provided for the primary alternator or battery temperature sensor.
3. Connect the temperature sensor to the Alt. #2 / Bat. #2 Temp. terminals on the regulator. It is essential that the terminals are connected to the correct pin. Connect the red wire to the positive terminal (#18) and the black wire to the negative terminal (#17).
4. Enter Basic Program Mode and change Ab2 to correspond to your sensing selection. See pg. 12

CAUTION: Reversing the polarity of the terminal connections on any of the alternator or battery temperature sensors can result in invalid sensing and potential damage to alternators, regulator and/or batteries.

Install Aux. 1 Lamp

The Max Charge MC-612-Dual regulator's Aux. #1 (#19) terminal provides the ability to use a visual indicator when the regulator is operating under the following conditions: Full field (the alternator is working at 95% or greater output) or Small Engine Mode (the regulator is being controlled at 50% field output). When a described condition is detected, the regulator sends the Aux. #1 terminal from neutral to ground. To utilize the Aux. #1 Lamp function:

1. Connect a small LED or incandescent lamp (maximum current flow is 500 mA) to a positive voltage source.
2. Connect the negative terminal on the lamp to the Aux. #1 terminal on the regulator.

Install Dash Lamp

The Max Charge Dash Lamp (#20) terminal provides the ability to activate a visual or audible indicator when the regulator monitors the following conditions: Low system voltage (ALL <12.7 volts), high system voltage (AHL <15.2 volts), high alternator temperature (AL or AL2), high battery temperature (b1L, b2L, or >55°C fixed limit) , high regulator temperature (>90°C), and alternator failure advisory (bdL) Temperature conditions are only indicated when appropriate temperature sensors are connected. When a described condition is detected, the regulator sends the Dash Lamp terminal from neutral to ground. To utilize the Dash Lamp function:

1. Connect a small LED or incandescent lamp, or an audible (piezo) alert (maximum current flow is 500 mA) to a positive voltage source.
2. Connect the negative terminal on the lamp or audible alert to the Dash Lamp terminal on the regulator.
3. When connected, the lamp should flash at regulator start-up to indicate active status.

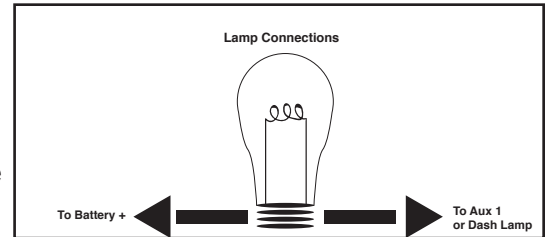

Magnetic Reed Switch

Looking much like a small thermometer atop the regulator's circuit board, the magnetic reed switch provides a durable, sealed interface that enables the user to set basic and advanced regulator programming features. Included with the regulator is a small screwdriver that doubles as the regulator's programming tool. A small magnet embedded in the tip of the screwdriver's handle allows the user to activate the magnetic reed switch. By holding the magnet to the RED dot located at the end of the reed switch, the user allows the user to scroll through the regulator's various program modes and individual program selections.

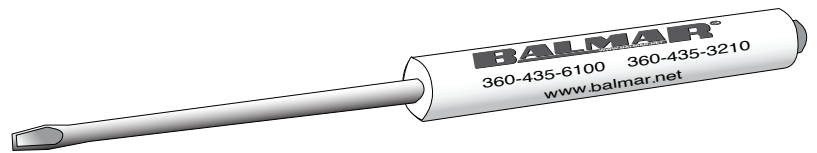

Initial Pre-Flight Test And Start-Up

When the regulator is properly mounted and the regulator wiring is installed, the MC-612-DUAL is ready for pre-flight testing.

Before turning on the engine, it is advisable to check voltages at the following terminal connections to ensure that the wiring is correct. Test #1 verifies proper voltage values with the regulator turned off. Test #2 verifies the expected voltages with the regulator turned on.

Note: If the regulator's BROWN ignition wire is receiving its switched source of voltage from an oil pressure switch, it may be necessary to start the engine before applying test #2. If the engine must be run to accomplish test #2, be sure that both alternators are properly cabled on both positive and negative sides to the battery being charged. Failure to do so could result in damage to the regulator and alternators.

Using your hand-held multi-meter, test the following wiring terminals for voltage:

TEST #1: Engine/Ignition Off

- Primary RED Power Wire (Terminal #5) >12V
- Secondary RED Power Wire (Terminal #4) >12V
- Positive Voltage Sense Wire (Terminal #12) >12V
- BROWN Ignition Wire (Terminal #3) 0V
- Primary BLUE Field Wire (Terminal #2) 0V
- Secondary BLUE Field Wire (Terminal #1)

TEST #2: Engine/Ignition ON

- Primary RED Power Wire (Terminal #5) >12V
- Secondary RED Power Wire (Terminal #4) >12V
- Positive Voltage Sense Wire (Terminal #12) >12V
- BROWN Ignition Wire (Terminal #3) >12V
- Primary BLUE Field Wire (Terminal #2) 4-12V
- Secondary BLUE Field Wire (Terminal #1) 4-12V

Regulator Operation

The MC-612-DUAL regulator's microprocessor controlled charging system uses a sophisticated, multi-stage profile to deliver maximum charging output, while protecting the batteries from overcharging damage. When the regulator is first turned on, the processor performs a quick one-second self diagnostic assessment. Following that diagnostic, the MC-612-DUAL initiates the selected battery charge program. Note that the Factory-set default values mentioned below correspond to the UFP battery program which is enabled by default. The battery program is as follows.

1. **Start Delay.** Controls time between regulator activation and the start of charging. Factory set at one second. User adjustable with dLc (See page 14)
2. **Soft Ramp.** Gently increases target voltage from current battery resting voltage to the Bulk Charge stage target at a fixed rate of 0.04 volts per second. This stage typically takes 1-2 minutes to complete.
3. **Bulk Charge.** The most aggressive of the charging stages. Target voltage is held to a preset level for a set time period, both of which are specified by the battery program selected. Factory-set values are 14.1 Volts for 0.3 hours (18 minutes), and are adjustable with bv and b1c, respectively (See page 14).
4. **Calculated Bulk Charge.** Target voltage is maintained at Bulk level. The regulator calculates battery condition by constantly monitoring field duty cycle, battery sense voltage, and an internal timer. Depending on these conditions, the regulator will stay in Calculated Bulk stage between 2 seconds and a fixed 6 hour time limit. If the 6 hour limit is exceeded it will automatically transition to the following stage. The field duty cycle target (FBA) is user adjustable. Factory set default is 65% (See page 15).
5. **Ramp to Absorption.** Gradually changes the target voltage from the current battery sense voltage to the Absorption Charge stage target at a fixed rate of 0.02 volts per 7 seconds. This stage typically takes 1 minute to complete.
6. **Absorption Charge.** The alternator output is held at a set voltage for a set time period, specified by the battery program selected. Factory-set values are 13.9 volts for 0.3 hours (18 minutes) and are adjustable with Av and A1c, respectively (See page 14).
7. **Calculated Absorption Charge.** Target voltage is maintained at the Absorption Charge level. The regulator calculates battery condition by constantly monitoring field duty cycle, battery sense voltage, and an internal timer. Once all conditions are met, the regulator will transition to the next stage. The time duration of this stage is between 2 seconds and 6 hours, depending upon battery condition. If the 6 hour limit is exceeded the regulator will automatically transition to the following stage. The field duty cycle target (FBA) is user adjustable. Factory set default is 65% (See page 15).
8. **Ramp to Float.** Gradually changes the target voltage from the current battery sense voltage to the Float Charge stage target at a fixed rate of 0.02 volts per 3 seconds. This stage typically takes about 1 minute to complete.
9. **Float Charge.** The alternator output is held at a preset voltage for a set time period, again, specified by the battery program selected. Factory-set defaults are 13.4 volts for 0.3 hours (18 minutes), adjustable with Fv and F1c, respectively (See page 14 & 15).
10. **Calculated Float Charge.** Target voltage is maintained at the Float level. The regulator can respond to an increased charge demand by reverting to the Absorption Charge stage if the conditions warrant. The battery condition is judged by constantly monitoring field duty cycle, battery sense voltage, and an internal timer. The regulator will stay in the Calculated Float charge stage a minimum of 2 seconds and up to 6 hours. If the 6 hour limit is exceeded the regulator will automatically revert to the absorption charge stage. The field duty cycle threshold (FFL) is user adjustable. Factory set default is 65% (See page 15).

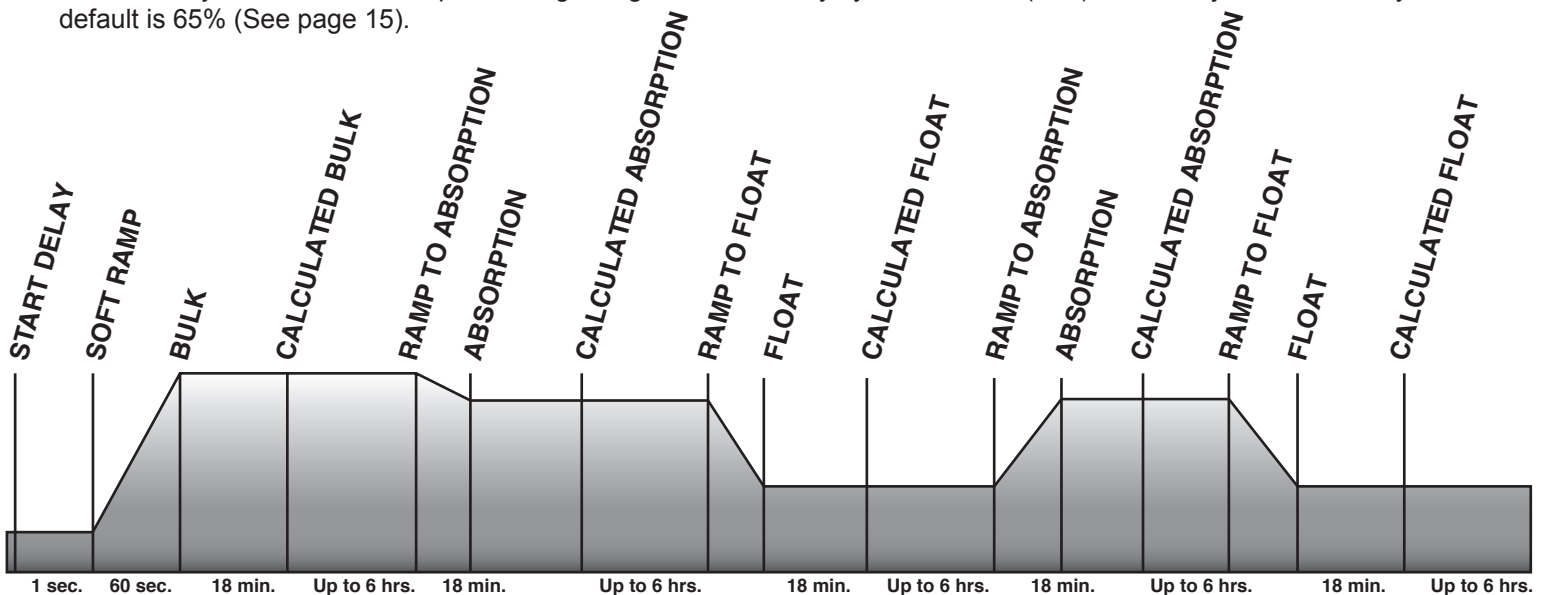

Regulator Display Modes - Short Display / Long Display

The regulator's three digit alphanumeric LED display provides a scrolling view of charging status. Under normal operation, the display will indicate the following:



BAL Indicates Balmar



6-d Indicates Model MC-612-DUAL



UFP Indicates regulator's default Universal Factory Program. Display will vary based on program selected.



b-0 Indicates the regulator's Belt Load Manager setting. Ranges from b-0 to b-9



-b- Indicates stage of charge. "-b-" indicates bulk. "-A-" indicates absorption. "-F-" indicates float. "-r-" indicates ramp.



bv Indicates system Battery Voltage. Followed by actual voltage reading.



Cv Indicates Calculated Voltage (Target voltage based on preset program levels). Followed by voltage reading.



b1 Indicates Battery #1 Temperature. Followed by NC (not connected), or temperature in Celsius.



AL Indicates Alternator #1 temperature. Followed by NC (not connected), or temperature in Celsius.



b2 Indicates Battery #2 temperature. Followed by NC (not connected), or temperature in Celsius.



AL2 Indicates Alternator #2 Temperature. Followed by NC (not connected), or temperature in Celsius.

*Alt. #2 or Bat. #2 Temperature Sensing are user selectable. One or the other will be shown in the regulator display.

In addition to the information provided in the basic display shown above, the MC-614 long display provides the following data. The long display is accessed during basic programming, which will be discussed in the next section of the manual.



FE Indicates the percentage of field output to the alternator. The higher the percentage, the greater the output.



r4.1 Indicates regulator's software revision code.



SP Indicates internal regulator temperature. Followed by degrees Celsius.



SLP Indicates, in millivolts, the value used to control voltage compensation for battery temperature.



Hr. Indicates overall regulator hours. Followed by hours and hours in hundreds of hours.



FbA Indicates field threshold for Bulk and Absorption. Factory set at 65%. Adjust in advanced programming mode.



FfL Indicates field threshold for Float. Factory set at 65%. Adjust in advanced programming mode.



E Indicates System advisory codes. Individually numbered codes are defined below.

The following advisory codes can be used to determine possible system errors or to identify specific operational modes. Note that E codes are cumulative and will be held in memory until cleared. Codes can be by cycling from LD to SD in the basic programming mode, and back to LD after the SD mode has been saved. See basic programming for more info.

E10 BATTERY #1 SENSOR CABLE SHORTED

E11 BATTERY #1 TEMP. SENSOR CABLE OPEN OR NOT FOUND

E12 BATTERY #2 TEMP. SENSOR CABLE SHORTED

E13 BATTERY #2 TEMP. SENSOR CABLE OPEN OR NOT FOUND

E14 ALTERNATOR #1 TEMP. SENSOR CABLE SHORTED

E15 ALTERNATOR #1 TEMP. SENSOR CABLE OPEN OR NOT FOUND

E16 ALTERNATOR #2 TEMP. SENSOR CABLE SHORTED

E17 ALTERNATOR #2 TEMP. SENSOR CABLE OPEN OR NOT FOUND

E20 BATTERY #1 TOO HOT. OVER 52°C. FACTORY DEFAULT

E21 BATTERY #2 TOO HOT. OVER 52°C. FACTORY DEFAULT

E22 ALTERNATOR #1 TOO HOT. OVER 108°C.

E23 ALTERNATOR #2 TOO HOT. OVER 108°C.

E24 VOLTAGE REGULATOR TOO HOT. OVER 90°C.

E33 BATTERY SENSE WIRE OPEN OR NOT FOUND USER AD

E40 BATTERY VOLTAGE TOO HIGH. OVER 16 VOLTS.

E41 FIELD VOLTAGE TOO HIGH

E42 STATOR VOLTAGE TOO HIGH

E51 SMALL ENGINE MODE IS IN OPERATION

E53 BATTERY #2 TEMPERATURE SENSE MODE

E54 ALTERNATOR #2 TEMPERATURE SENSE MODE

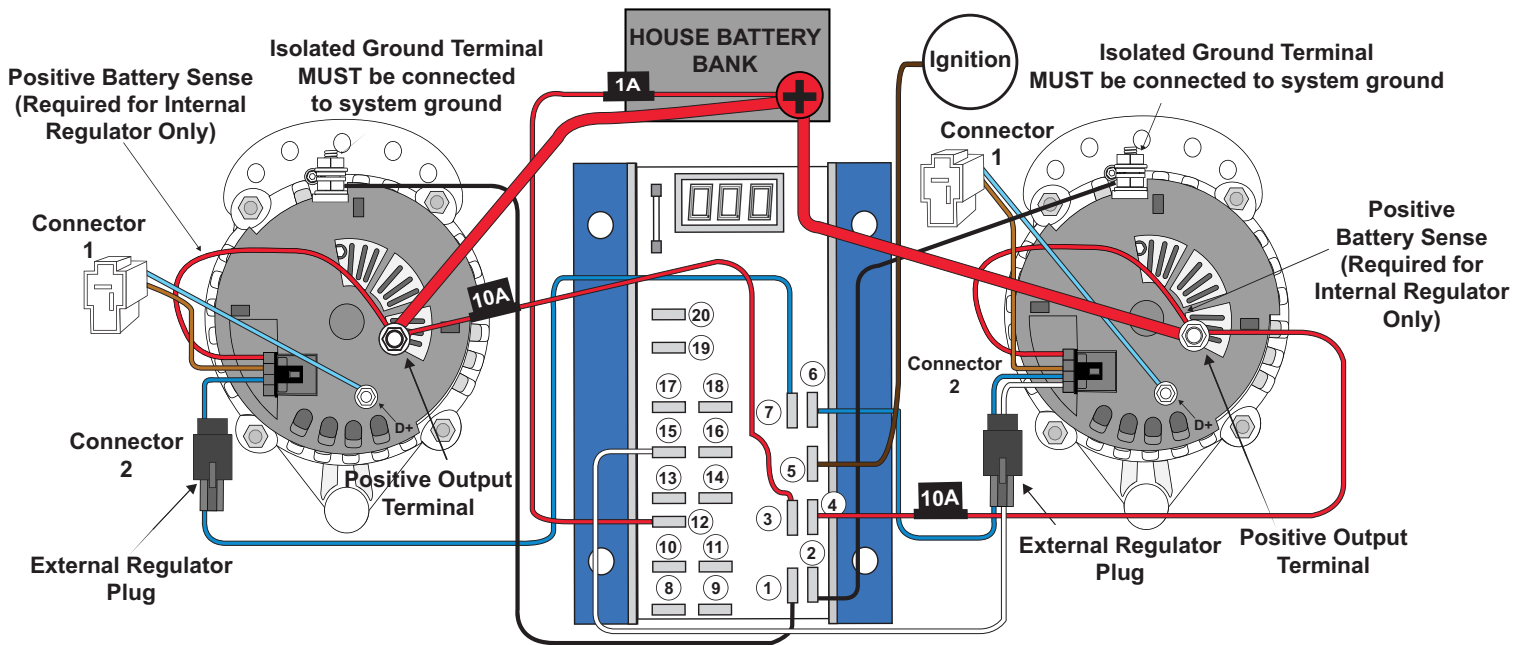

Preset, Multi-Stage Battery Programs	Balmar Regulators				Digital Duo Charge	Dual Engine Centerfielder
	12 Volt			24 Volt		
	ARS-5	MC-614	MC-612-DUAL	MC-624		
Universal Factory Program, Deep Cycle Flooded, Gel Cell, Absorbed Glass Mat (AGM) and Spiral Wound Flooded (Optima)	Yes	Yes	Yes	Yes	Yes	Yes
Standard Flooded, Lithium	-	Yes	Yes	Yes	Yes	Yes
Halogen Systems	-	Yes	Yes	-	Yes	Yes
Balmar Alternator Models						
6-Series Alternators (70A-150A)	Yes	Yes	Yes	Yes	Yes	Yes
AT-Series Alternator (165A-200A)	-	Yes	Yes	-	Yes	Yes
9-Series Large Case Alternators (140A-310A)	-	Yes	Yes	Yes	Yes	Yes
Multiple Alternator/Engine Configurations						
Dual Engine, One Alternator Each	-	Yes (qty 2)	-	Yes (qty 2)	Yes	Yes
Single Engine, Two Alternators	-	-	Yes	Yes (qty 2)	Yes	Yes

Regulator Programming Modes

Using The Magnetic Reed Switch

Control of the MC-612-DUAL regulator's basic and advanced programming modes is provided by a magnetic reed switch located in the upper left corner of the regulator's circuit board. The reed switch provides selectable control of the regulator's programming without creating an intrusion point as is common on many other adjustable voltage regulators currently on the market.

A small screwdriver with a magnet embedded in the tip of the handle is included to activate the magnetic reed switch. While any magnetic tip tool can be used, the Balmar programming screwdriver does an excellent job as an interfacing tool.

Programming is accomplished by contacting and removing the magnet from the RED dot affixed to the regulator's epoxy potting. If the magnet has difficulty activating the reed switch at that position, try moving it up and down along the length of the reed switch until the RED light is illuminated at the top of the LED display, between the second and third display digits. The RED light indicated activation of the reed switch.

Within the basic and advanced programming instructions, activation of the reed switch will be described by the following actions:

TOUCH/RELEASE - Indicates the action of contacting and immediately removing the magnet from the reed switch

TOUCH/HOLD - Indicates the action of contacting and holding the magnet to the reed switch

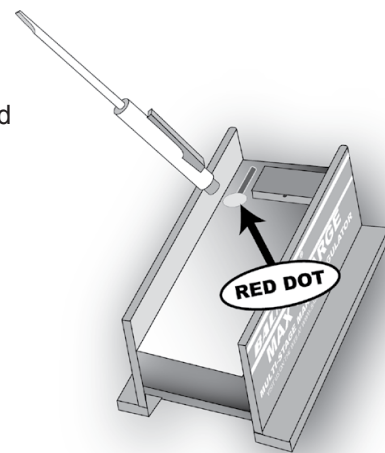

Basic Programming

Programming For Battery Type

The MC-612-DUAL features selectable programs for the following battery technologies; Standard Flooded (FSb), Deep Cycle Flooded (FdC), Gel (gEL), AGM (AgL), Optima (OPS), a factory default program (UFP), a program for systems with voltage sensitive halogen equipment (HAL), and LiFePO₄ (LFP).

When activating the programming mode, keep in mind that the regulator will scroll through the basic programming mode three times before saving and returning to the operational mode. To adjust the regulator for your battery type:

1. Turn on the regulator. This may be accomplished by turning the ignition switch at the panel to the ON position. If the regulator's BROWN ignition wire is connected to an oil pressure switch, it may be necessary to start the engine to activate the regulator.
2. Once the regulator is on and the display is scrolling, TOUCH/HOLD the magnetic end of the programming screwdriver to the RED dot on the regulator as described above.
3. Continue to hold the magnet to the RED dot. The letters PRO will appear on the LED.
4. Continue to hold the magnet to the RED dot. The letters BA will appear on the LED.
5. Continue to hold the magnet to the RED dot. The LED display will begin to scroll through the various battery codes.
6. When the desired battery code is displayed, RELEASE the magnet from the RED dot.
7. The Display will indicate BA once again. At this point, you have the option to re-enter the battery type mode by re-applying the magnet to the RED dot. Otherwise, the display will cycle to bEL, indicating entry into the Belt Load Manager mode.

Pro INDICATES ENTRY INTO BASIC PROGRAMMING MODE

gEL INDICATES PROGRAM FOR DEEP CYCLE GEL BATTERIES

HAL INDICATES PROGRAM FOR HALOGEN SYSTEMS

bA INDICATES ENTRY INTO BATTERY TYPE PROGRAM MODE

AgL INDICATES PROGRAM FOR ABSORBED GLASS MAT BATTERIES

LFP INDICATES PROGRAM FOR LiFePO₄

UFP INDICATES FACTORY DEFAULT UNIVERSAL FACTORY MODE

OPS INDICATES PROGRAM FOR SPIRAL WOUND (OPTIMA)

FdC INDICATES PROGRAM FOR DEEP CYCLE FLOODED BATTERIES

FSb INDICATES PROGRAM FOR STD. FLOODED BATTERIES

LFP LiFePO₄ Recommendations

Our LFP program is a generalized version of the recommendations provided by the top LFP battery manufacturers. For best performance and compatibility, please consult your battery manufacturer and use the regulator's advanced programming features to adjust the LFP program as needed. LFP batteries are more sensitive to abuse than a traditional chemistry battery and can fail catastrophically. It is HIGHLY recommended that the charging system as a whole be installed or inspected by a qualified marine electrical installer that has experience with Balmar charging system products and LFP batteries. The LFP profile is intended to work with the battery manufacturer's battery management systems (BMS). The LFP profile IS NOT a replacement for a BMS.



Many LiFePO₄ batteries have a Battery Management System (BMS) that may disconnect the battery from the alternator as a protective action or when charging is complete. The regulator must be shut down before the battery is disconnected. Running an alternator without a battery will damage the alternator and may damage any attached system. This is doubly true if the battery can be disconnected during high current charging, causing a load dump. The load dump can easily cause a high voltage spike which will destroy the alternator's rectifier, at minimum. This is not a warrantable failure. To reiterate: **THE ALTERNATOR MUST BE SHUT DOWN BEFORE DISCONNECTING THE BATTERY. THE ONLY SAFE WAY TO SHUT DOWN THE ALTERNATOR IS TO TURN OFF THE REGULATOR.** The preferred method of turning off the regulator is disconnecting the regulator's ignition (brown) wire, but if used as an EMERGENCY ONLY shutdown, disconnecting the regulator's power input (red) wire in addition to the ignition wire has a very low chance of damaging the regulator.



LFP batteries will readily accept a damaging amount of current. Applying too much charge current to a LFP battery will, at the very least, permanently damage the battery's capacity. It is CRITICAL to ensure that the alternator is not capable of exceeding the maximum continuous charge current rating of your battery (or batteries). As always, check with your battery manufacturer for specifics. Your battery manufacturer may supply you with a "C-rate" for charging and discharging. The maximum amount of charging current your battery can safely handle is determined by multiplying the "C-Rate" by the capacity of the bank. i.e. 4x 100Ah 12V batteries rated at 0.5C charge = 400 Ah * 0.5C = 200amps MAX. If your alternator is capable of outputting more current, at any time or condition, than the battery (or batteries) can handle, you may use the Belt Manager feature on the MC-612 DUAL to lower the maximum field drive output, and thereby lower the maximum alternator output current. See page 10 of your regulator manual for details and instructions. Be aware that it is not an exact 1:1 correlation between field output and alternator output, so start with more reduction (lower output) than you think you need and adjust accordingly.



It is strongly recommended that an alternator temperature sensor (MC-TS-A) be used when charging LFP batteries. Given the extremely high charge acceptance rate of LFP batteries, the alternator will be driven to full output for almost all of the charge cycle. This can cause overheating in automotive style alternators resulting in a significantly shortened lifespan. When equipped with the MC-TS-A temperature sensor, the MC-612-DUAL will help you protect your investment by performing active alternator temperature control. This is accomplished by scaling back the field voltage to the alternator when over the "AL1" temperature threshold. If you cannot use an MC-TS-A in your application, you should monitor the alternator's temperature (measure as close to the loop ends of the stator as possible) and discontinue charging if the alternator temperature rises above the maximum recommended level. You may also use the Belt Manager feature on your MC-612-DUAL to reduce maximum output until a tolerable alternator temperature is maintained under all conditions.



Most LFP battery manufacturers specify minimum and maximum charging temperatures to be from freezing (32°F, 0°C) to around 111°F (44°C). Again, consult with your battery manufacturer for specifics. When equipped with a MC-TS-B, the MC-612-DUAL can disable charging if the battery temperature exceeds the "B1L" temperature threshold and re-enable charging when the temperature drops below the threshold. This feature is meant to supplement, not replace, your BMS's temperature protection features. "B1L" should be adjusted to be slightly less than BMS's temperature threshold. Note that the regulator does not have the capability to prevent charging during low temperatures.

Programming The Belt Load Manager

The MC-612-DUAL provides the ability to manage regulator field potential, making it possible to govern the horsepower loads placed on the drive belt(s) by the alternator. The Belt Load Manager can also be used to protect the alternator from extraordinary load created by a battery load that's too large for the alternator's capacity. The Belt Load Manager is accessed in the basic programming mode, directly after the battery type programming mode. The Belt Load Manager can be accessed at the same time the battery program is set, or by itself.

To adjust the Belt Load Manager setting:

1. TOUCH/HOLD when entry into the Belt Load Manager display selector is indicated by bEL on the regulator's LED.
2. The regulator display will cycle through the bEL settings.
3. RELEASE when the display indicates your desired setting. The display will cycle to bEL. You can re-activate to change your selection, or wait until the regulator cycles to the next programming mode.

 **bEL** INDICATES ENTRY INTO BELT LOAD MANAGER MODE

 **b-3** INDICATES bEL SETTING #3. FIELD REDUCTION 15%.

 **b-7** INDICATES bEL SETTING #7. FIELD REDUCTION 35%.

 **b-0** INDICATES bEL OFF.

 **b-4** INDICATES bEL SETTING #4. FIELD REDUCTION 20%.

 **b-8** INDICATES bEL SETTING #8. FIELD REDUCTION 40%.

 **b-1** INDICATES bEL SETTING #1. FIELD REDUCTION 5%.

 **b-5** INDICATES bEL SETTING #5. FIELD REDUCTION 25%.

 **b-9** INDICATES bEL SETTING #9. FIELD REDUCTION 45%.

 **b-2** INDICATES bEL SETTING #2. FIELD REDUCTION 10%.

 **b-6** INDICATES bEL SETTING #6. FIELD REDUCTION 30%.

Programming For Secondary Alternator OR Regulator Temperature Sensor

The regulator allows the user to select between the use of a second battery temperature sensor, or a second alternator temperature sensor, depending on the application and preference. To adjust the regulator for secondary sensor type:

1. TOUCH / HOLD when entry into the temperature sensor selector is indicated by the Ab2 display on the LED.
2. The regulator display will indicate codes AL2 (for alt. temp. sensor #2) or b2 (for bat. temp. sensor #2).
3. RELEASE when the display indicates your desired temperature sensor type. The display will cycle to Ab2. You can re-activate to change your selection, or wait until the regulator cycles to the next programming mode.
4. The display will cycle to dSP, indicating the selection mode for short (Sd) or long (Ld) regulator displays.

 **Ab2** INDICATES ENTRY INTO ALT/BAT #2 SELECTOR MODE

 **AL2** INDICATES SELECTION MODE FOR 2ND ALTERNATOR SENSE

 **b2** INDICATES SELECTION MODE FOR 2ND BATTERY SENSE MODE

 **dSP** INDICATES ENTRY INTO SHORT OR LONG DISPLAY MODE

Programming For Short or Long Display Mode

You can choose the amount of information displayed on the regulator. The information displayed on the short or long display is detailed on Page 8 of the manual.

To adjust the regulator for short or long display:

1. TOUCH/HOLD when entry into the short/long display selector is indicated by dSP on the regulator's LED.
2. The regulator display will indicate codes Sd (for short display) or Ld (for long display).
3. RELEASE when the display indicates your desired display mode. The display will cycle to dSP. You can re-activate to change your selection, or wait until the regulator cycles to the next programming mode.

 **dSP** INDICATES ENTRY INTO SHORT OR LONG DISPLAY MODE

 **Sd** INDICATES SHORT DISPLAY MODE

 **Ld** INDICATES LONG DISPLAY MODE

Programming For Alternator Failure Advisory Mode (BDL)

The regulator provides a ground signal on the dash lamp terminal when the following conditions occur: low battery voltage (<12.7V), high battery voltage (>15.5V), high battery temperature (<52°C), or high alternator temperature (105°C). In addition, the user has the option to send the dash lamp ground in the event that the stator output drops to zero volts. The Regulator's Default bdL setting is ON. Monitoring stator output is an optional function which can be turned on or off in the basic programming mode. The regulator's default setting for the bdL mode is ON, meaning that the stator output is being monitored. This function can be used in conjunction with a relay to control a charge indicator lamp.

1. To enable or disable the stator monitoring function, activate and hold when the bdL mode is indicated.
2. Release when the desired setting is shown. NOTE: Stator wire must be connected to the regulator's Stator-In terminal to use this function.

 **bdL** INDICATES ENTRY INTO ALTERNATOR FAILURE ADVISORY MODE

 **OFF** STATOR OUTPUT MONITORING OFF

 **On** STATOR OUTPUT MONITORING ON

Regulator Programming Flow Chart (See pages 10-15)

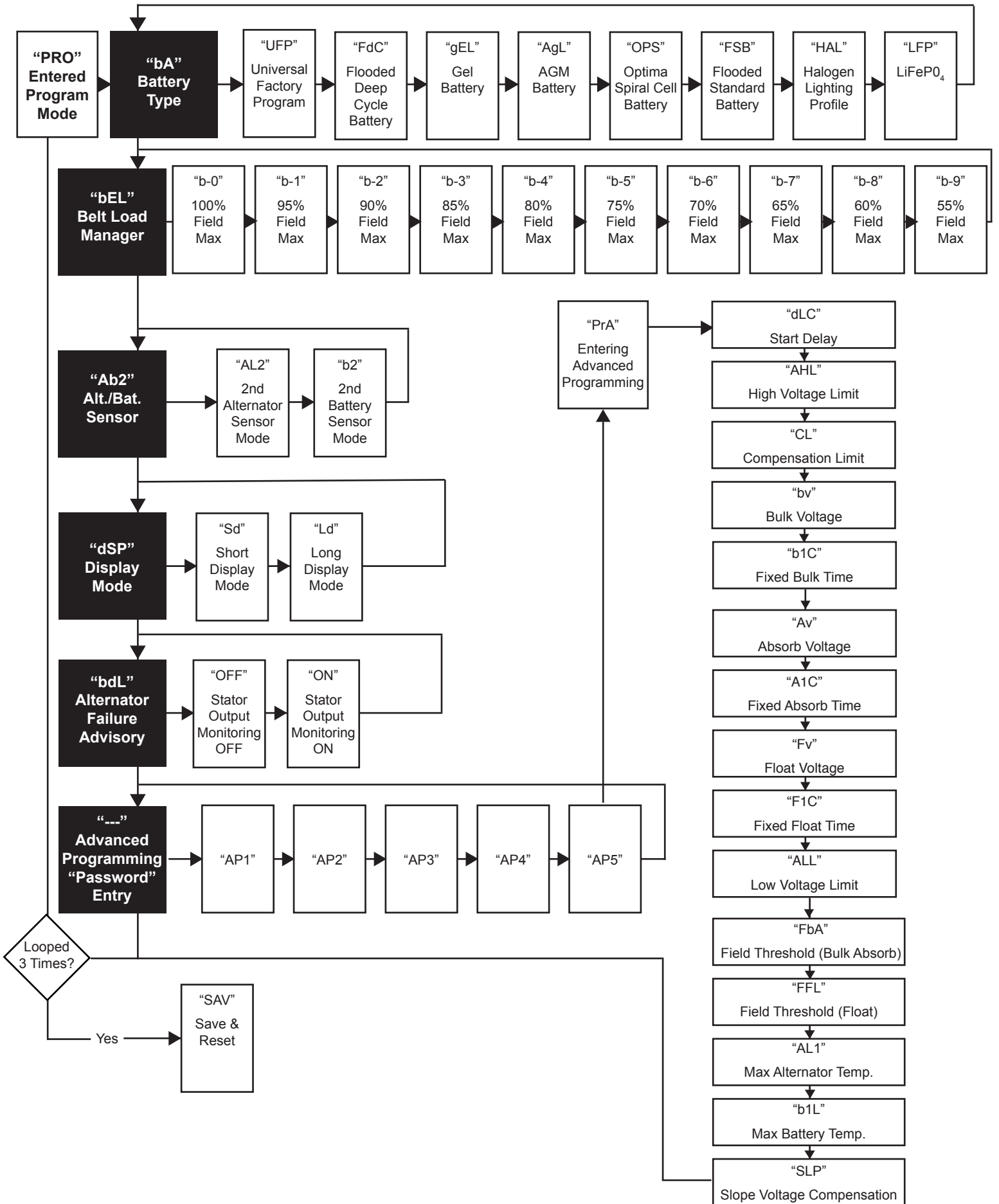

Advanced Programming Modes

Accessing The Advanced Programming Mode

The MC-612-DUAL provides a broad range of advanced user adjustments in its password-protected Advanced Program Mode. The Advanced Program mode is accessed via the Basic Program mode. To access the Advanced Program mode:

1. With the regulator activated, TOUCH/HOLD the magnet to the RED dot on the regulator's epoxy potting.
2. The regulator will cycle to PRO. RELEASE the magnet from the switch.
3. The regulator will cycle through all of the Basic Program modes; bA, bEL, dSP, and bdL followed by three dashes.
4. TOUCH/HOLD when the three dashes are displayed. The dashes will be replaced by AP0 followed by AP1, and so on.
5. When the display indicates AP5, RELEASE.
6. The display will cycle to PrA, indicating entry into the Advanced Programming mode.



PRO INDICATES ENTRY INTO PROGRAM MODE



dSP INDICATES SELECTION MODE FOR SHORT/LONG DISPLAY



AP1 INDICATES ENTRY INTO PASSWORD MODE FOR AP MODE



bA INDICATES SELECTION MODE FOR BATTERY TYPE



bdL INDICATES ALTERNATOR FAILURE ADVISORY (BDL)



AP5 INDICATES PASSWORD FOR ADVANCED PROGRAM MODE



bEL INDICATES SELECTION MODE FOR BELT LOAD MANAGER



--- INDICATES ENTRY INTO PASSWORD MODE FOR AP MODE



PrA INDICATES ENTRY INTO THE ADVANCED PROGRAM MODE

Making Advanced Programming Adjustments

Once accessed, the Advanced Program mode allows the user to adjust time, voltage and temperature setting for the active battery program. Adjustments made are semi-permanent meaning they will be saved until the battery program is changed. All defaults shown below are for the UFP program and will vary depending on which program you have selected. To change the settings TOUCH/HOLD the magnet to the RED dot on the epoxy potting when the desired mode is indicated. When the reed switch is engaged, the values for the various modes will scroll upward or downward. To reverse the direction of scroll:

1. REMOVE the magnet from the reed switch.
2. Wait for the mode indicator to be displayed.
3. TOUCH/HOLD when the mode indicator is displayed. The values for that mode will begin to scroll in the opposite direction. Continue to HOLD until the desired value is displayed.
4. REMOVE the magnet from the RED dot. The mode indicator will be displayed again, followed by the indicator for the next Advanced Programming mode.

The Advanced Programming Modes are as follows:



(PrA) Advanced Program Mode. Once the correct password is used to unlock the Advanced Program mode, the PrA display will be immediately followed by Advanced Programming modes. The Advanced Programming modes include:



(dLc) Start Delay. Controls time from regulator activation to start of charging. Factory preset at one second. Adjustable to a maximum of 200 seconds.



(AHL) High Voltage Limit. Controls high voltage alarm threshold. Adjustment spans from cl to 16 volts. Default is 15.2 volts adjustable in .1 volt increments. See information for Battery Equalization for more details on AHL adjustment.



(CL) Compensation Limit. Controls maximum allowable temperature compensated system voltage. Adjustment spans from bv to AHL. Default is 14.8 volts. Adjustable in .1 volt increments.



(bv) Bulk Voltage. Controls the target voltage for bulk charge mode. Adjustment spans from Av to cL. Default is 14.1 volts adjustable in .1 volt increments.



(b1c) Bulk Time. Controls minimum time in Bulk Mode before entering Calculated Bulk. Standard value set is .3 hours (18 minutes). Settings are from 6 minutes to 6 hours. Adjustable in .1 hrs (6 minute) increments.



(Av) Absorption Voltage. Controls the target voltage for absorption charge mode. Adjustment spans from Fv to bv. 13.9 V default, adjustable in .1 volt increments



(A1c) Absorption Time. Controls minimum time in Absorption Mode before entering Calculated Absorption. Standard value set is .3 hours (18 minutes). Settings are from 6 minutes to 6 hrs. Adjustable in .1 hrs (6 minute) increments.



(Fv) Float Voltage. Controls the target voltage for float stage. Adjustment spans from ALL to Av. Default is 13.4 volts, adjustable in .1 volt increments.



(F1c) Float Time. Controls minimum time in Float Mode before entering Calculated Float. Standard value set is .3 hours (18 minutes). Settings are from 6 minutes to 6 hrs. Adjustable in .1 hrs (6 minute) increments.



(ALL) Low Voltage Limit. Allows user control of regulator's low voltage limit. Spans between 10 volts and Fv. Dropping below ALL causes Dash Lamp to turn on. Default is 12.7 volts in .1 volt increments.



(FbA) Field Threshold - Bulk and Absorption. Controls the field output threshold required to cycle from Bulk to Absorb and Absorb to Float. Factory set at 65% of field output. Raising "FbA" shortens calculated bulk and absorption charge time. Adjusted in 1% increments. Span of adjustment is 16% to 96%.



(FFL) Field Threshold - Float to Absorption. Controls the field output threshold required to cycle from float to absorption charging modes. Factory set at 65%. Raising "FFL" increases calculated float charge time. Adjusted in 1% increments. Span of adjustment is 16% to 96%.



(AL1) Alternator Temperature Threshold. Controls the Alternator over temperature set point. Requires MC-TS-A temperature sensor to be connected to the Alt. Temp. #1 and/or Alt. #2 temperature sensor terminals. Preset at 100°C. Spans from 60-128°C. Adjustable in 1°C increments.



(b1L) Battery Temperature Threshold. Controls the Battery over temperature set point. Requires MC-TS-B temperature sensor to be connected to the Bat. Temp. #1 and or Bat. #2 temperature sensor terminals. Preset at 52°C. Spans from 42-56°C. Adjustable in 1°C increments.



(SLP) Slope Voltage Correction. Adjusts the voltage (in millivolts) the regulator uses when monitoring battery temperature sensing. Can be custom adjusted to meet the needs of unique battery technologies. Consult with battery manufacturer for specific slope voltage recommendations. Spans from 0 to 8.3 millivolts per degree Celsius. Default is 6.0 mV/°C. Adjustable in 0.1mV/°C increments.

Battery Equalization

Due to the hazardous nature of equalization (the intentional overcharging of batteries to remove sulfation from the battery plates) we strongly recommend that the process be done at the dock with a voltage-adjustable shorepower charger. If it is absolutely impossible to do so, equalization can be done with the alternator and regulator by entering into Advanced programming (Pra) and changing the following values:

1. Cl to a voltage above the desired equalize voltage.
2. AHL to a voltage above the desired equalize voltage.
3. bv to the desired equalize voltage.
4. b1c to the desired equalize time.
5. Disconnect ALL battery temperature sensors.

YOU MUST MONITOR THE BATTERIES DURING EQUALIZE PROCESS!

6. Once the equalization is complete, activate the regulator's basic programming and reset the battery program mode to UFP, and allow the program to save. Once saved, access the basic programming mode again and reset for the desired battery program.

**WARNING: EQUALIZATION IS A MANUAL PROCESS WITH POTENTIAL DANGERS.
DO NOT LEAVE SYSTEM UNATTENDED.**

Default Program Settings By Battery Type

	UFP	Fdc	gEL	AgL	OPS	FsB	HAL	LFP
START DELAY (SECS.)	1	1	1	1	1	1	1	1
HIGH VOLTAGE LIMIT (VOLTS)	15.2	15.6	15.1	15.4	15.6	15.4	15.0	14.8
COMPENSATION LIMIT (VOLTS)	14.8	14.8	14.8	14.8	14.8	14.8	14.8	14.8
BULK VOLTAGE	14.1	14.6	14.1	14.4	14.6	14.4	14.0	14.3
BULK TIME (MINIMUM)	18 MIN	18 MIN	18 MIN	18 MIN	18 MIN	18 MIN	18 MIN	6 MIN
ABSORPTION VOLTS	13.9	14.4	13.9	14.2	14.4	14.2	13.8	13.6
ABSORPTION TIME (MINIMUM)	18 MIN	18 MIN	18 MIN	18 MIN	18 MIN	18 MIN	18 MIN	18 MIN
FLOAT VOLTS	13.7	13.4	13.7	13.4	13.4	13.4	13.5	13.4
FLOAT TIME (MINIMUM)	18 MIN	18 MIN	18 MIN	18 MIN	18 MIN	18 MIN	18 MIN	18 MIN
FLOAT TIME (MAX FIXED)	6 HRS	6 HRS	6 HRS	6 HRS	6 HRS	6 HRS	6 HRS	6 HRS
LOW VOLTAGE LIMIT (VOLTS)	12.7	12.7	12.7	12.7	12.7	12.7	12.7	12.7
MAX ALT. TEMP.	125°F/52°C	125°F/52°C	125°F/52°C	125°F/52°C	125°F/52°C	125°F/52°C	125°F/52°C	111°F/44°C
MAX BAT. TEMP.	212°F/100°C	212°F/100°C	212°F/100°C	212°F/100°C	212°F/100°C	212°F/100°C	212°F/100°C	212°F/100°C
BAT. TEMP. COMPENSATION	6.0mV/°C	6.0mV/°C	5.0mV/°C	3.8mV/°C	5.0mV/°C	6.0mV/°C	5.0mV/°C	0.0mV/°C

Additional Regulator Features

Small Engine Mode

In situations where additional power is needed for propulsion, the MC-612-DUAL provides the option to manually reduce regulator field output by approximately one half. This option, called Small Engine Mode, can be accessed by shorting the positive and negative Alternator #1 Temperature Sensor terminals. This can be done by splicing into the positive and negative wires of the Alternator Temperature Sensor cable (MC-TS-A) with a switched wire. With the switch in the OFF position, the Alternator #1 Temperature Sensor will work normally. With the switch in the ON position, the regulator will reduce field output by approximately 50%. To enable the Small Engine Mode:

1. If the Alternator Temperature Sensor cable is being used, replace the female terminal connectors on the cable with Multi-Stack Connectors (Ancor Part # 230612).
2. Install a standard ON/OFF switch in a location that's easily reached from the helm.
3. Run wires from the switch back to the positive and negative terminals of the Alternator #1 Temperature Sensor terminals (#5 and #6).
4. Add appropriate connectors to the switched wires and connect to the positive and negative terminal connections.

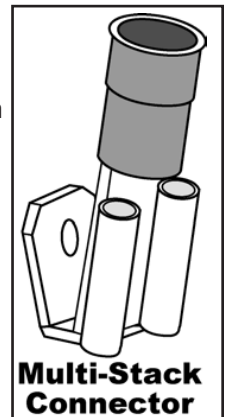

Dash Lamp

The MC-612-DUAL provides a Dash Lamp circuit that's capable of providing a signal to a user supplied and installed audible or visual alert if the following issues were to occur while the regulator is in operation:

- Low Battery Voltage <12.8V Adjustable with "ALL." (See Page 15)
- High Battery Voltage >15.5V Adjustable with "AHL." (See Page 14)
- High Alternator Temperature 100°C Adjustable with "AL1." (See Page 15 Requires installation of MC-TS-A sensor)
- High Battery Temperature >52°C Adjustable with "B1L." (See Page 15 Requires installation of MC-TS-B sensor)
- Alternator Failure (No voltage on stator if bdL is enabled)
- Regulator Overtemp Fixed 90°C

Aux #1 Lamp

The MC-614 provides an Auxiliary Lamp circuit that's capable of providing a signal to a user supplied and installed audible or visual alert to indicate the following while the regulator is in operation:

- Small Engine Mode is activated
- Regulator is at full field

System Troubleshooting

Regulator Troubleshooting

The majority of charging difficulties can be attributed to damage, corrosion or wear at wiring, fusing or wiring connections. Before attempting to troubleshoot alternator or regulator issues, be sure to address the following:

1. Remove and clean all charging system electrical connections (positive and negative). Check the voltage regulator's harness for continuity. Wires and terminals can and will become corroded, and need to be cleaned or replaced. Ensure that the regulator's ground wires are provided with a clean connection to system ground.
2. Inspect and replace 10A and 1A ATC type fuses in the regulator wiring harness if fuse appear to be damaged or corroded. Ensure that the fuse holder is also free of corrosion.
3. Charge all batteries to their proper fully charged state, and determine if they are serviceable. If your batteries are flooded-type, use your hydrometer to determine their condition.
4. Check and tighten alternator belt. If the belt show signs of wear or damage, replace it. Always replace existing belts with the finest quality replacements available.

If batteries and wiring are in suitable condition, use the following tests to determine if charging problems are a result of a faulty alternator or regulator. These tests provide an opportunity to isolate the alternator, regulator and wiring harness in order to determine the problem source. In order to perform these tests, you will need an independent DC meter (preferably a digital type). In an emergency, a 12V light bulb or test light can be used to help determine if power or working grounds exist. An amp meter and a battery hydrometer with a thermometer are also helpful diagnostic tools.

Voltage Regulator Testing

Set your voltmeter to 12VDC and connect the negative lead to the BLACK ground wire at the regulator as shown at the diagram at right.

1. With the ignition turned OFF, check voltage on the RED (power), Voltage Sense (Terminal #9), BLUE (field) and BROWN (Ignition) wires in the regulator plug.

Voltages should be as follow:

- RED wire equal to battery voltage
 - Terminal #9 RED wire equal to battery voltage
 - BLUE wire zero volts
 - BROWN wire zero volts
2. With the ignition in the ON position (engine not running), check voltage on the RED (power), Secondary RED on Terminal #9 (voltage sense) BLUE (field) and BROWN (ignition) wires in the regulator plug:
 - RED wire equal to battery voltage
 - Terminal #9 RED wire equal to battery voltage
 - BLUE wire between 4V and 11V
 - BROWN wire equal to battery voltage

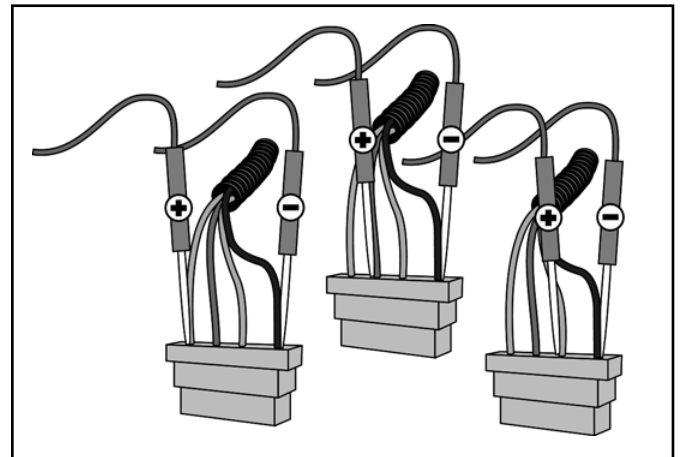

PLEASE NOTE: In systems where the ignition (BROWN) wire is supplied power via an oil pressure switch, jump directly from test #1 to test #3.

3. With the ignition in the ON position (with engine running at 1,400 rpm fast idle), check voltage on the RED (power), Secondary RED on Terminal #9 (voltage sense) BLUE (field) and BROWN (ignition) wires in the regulator plug. Voltages should be as follows:
 - RED wire equal to battery voltage
 - Terminal #9 RED wire equal to battery voltage
 - BLUE wire between 4V and 11V
 - BROWN wire equal to battery voltage

If voltage is not present on the RED, the BROWN and the Positive Battery Sense Wire, the regulator will not work. If voltage is as expected at the RED the BROWN and Positive Battery Sense wire, and there is zero, or an unexpected voltage reading at the BLUE wire, contact our technical support staff at +1(360) 435-6100, or e-mail us at balmar@balmar.net.

If all voltages at the regulator meet expectations, yet the alternator is not producing charging current, test the alternator. The following tests are recommended for determining alternator functionality.

Alternator Testing

TEST #1 - The following test is used to isolate the alternator and determine if the failure is a result of the alternator. Once again, testing at either the alternator or regulator is only effective if the wiring, fusing and batteries have been determined to be in correct working order. The alternator and regulator can be tested for function by determining if a magnetic field exists at the alternator's pulley shaft or rear bearing. To test:

1. With the ignition in the OFF position, place the tip of a non-magnetic steel screwdriver near the nut on the pulley shaft or near the rear bearing of the alternator. There should be no evidence of a magnetic field pulling the screwdriver toward the alternator. (A slight amount of magnetism may be present, due to residual voltage in the alternator).
2. Engage the ignition, without starting the engine, to activate the voltage regulator. If an oil pressure switch is used, a jumper between the RED and BROWN wires in the Ford-style plug will activate the regulator.
3. After allowing time for the regulator's start-up delay, place the head of a steel screwdriver near the nut on the pulley shaft or near the rear bearing of the alternator. There should be substantial magnetic pull. If a magnetic field is present, the voltage regulator, alternator brushes and rotor are likely to be working properly.

If there is little or no magnetic pull at the pulley shaft or at the rear bearing, initiate the following test:

With the key off and the engine off, remove the large harness plug from the regulator.

1. Insert the end of a short length of electrical wire to the RED connector slot of the regulator harness and the other end of the wire to the BLUE connector slot. This bypasses the regulator and tests the alternator and the harness.
2. Using your steel screwdriver, inspect for a magnetic field as described above.
3. With your voltmeter, check for voltage on the blue wire at the alternator. If voltage does not exist, the harness may be at fault. If voltage does exist at the harness, but no magnetism is present, the alternator is likely to be malfunctioning.
4. If a magnetic field is present. Both harness and alternator brushes and rotor appear to be working properly. If no magnetic field is present, proceed with the next test.

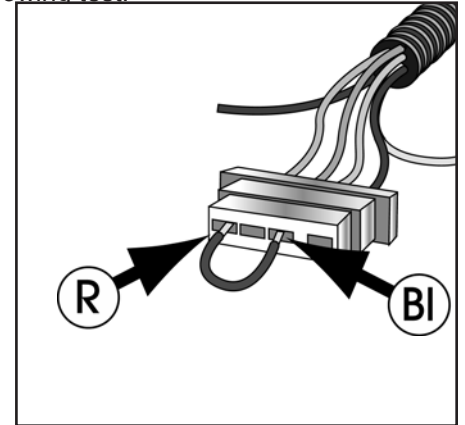

Testing the actual output of the alternator is known as "Full Field Testing". This can be accomplished by jumping a positive 12VDC current to the field terminal at the rear of the alternator. This test eliminates both the regulator and the harness, making it easier to isolate your investigation to the alternator.

CAUTION: Ensure that all voltage sensitive equipment is turned off prior to starting the engine. Voltage is unregulated during this test and could damage sensitive electronics. DO NOT let the engine run any longer than necessary to detect charging. If the system is not charging, remove the alternator and have it inspected by a qualified alternator shop, or call Balmar for warranty evaluation. To test the alternator:

1. Clip a jumper wire to the positive post of the alternator, or on the battery side of the isolator (if an isolator is in use). Use a SHIELDED alligator clip for post attachment. Unintentional contact between the alligator clip and the alternator case could result in damage to your electrical system.
2. Disconnect the field wire from the rear of the alternator and attach the other end of the jumper wire to the alternator's Field terminal (F). CAUTION: Do not allow the wire to contact the case while it is attached to the positive post. The case may be grounded and severe damage could occur.
2. The regulator is now bypassed. When the ignition is engaged and the motor is started, the voltage should rise and charging current should be present.
3. The motor should be run long enough to determine that charging voltage is present. Unregulated voltage can rise quickly. Do not allow extended unregulated charging to occur without carefully monitoring voltage levels. If the alternator fails to generate voltage during field testing, a malfunction of the alternator is likely. Contact your local alternator repair shop or Balmar's technical service staff for recommendations.

Conclusion

If your readings differ substantially from the "expected Readings" listed in the troubleshooting charts, the regulator may be malfunctioning, or there may be a continuity problem. Contact our technical support staff at +1(360) 435-6100. If you determine that repair service is necessary for either your alternator or regulator, please gather the following information before contacting our service technicians: Make and model of alternator. Model of voltage regulator and date of mfg. (date punched on rear side label of regulator). Voltage readings on RED, BROWN and BLUE wire at regulator with engine off, key on. Voltage readings on RED, BROWN and BLUE wire at regulator with engine running at a fast ideal 1400rpm.

Balmar Warranty

Balmar Limited Warranty

Balmar's Limited Warranty covers defects in material or workmanship on new Balmar products generally for a period of one (1) year from the purchase date. Only consumers or dealers purchasing Balmar products from authorized Balmar retailers or resellers and installed by a qualified installer may obtain coverage under Balmar's Limited Warranty. Components with a manufacturing date greater than ten (10) years old are not covered under the Balmar Warranty, even if the purchase date has been within the past two (2) years. Purchase from unauthorized resellers, which may include some online entities, may not guarantee the purchaser will receive a newly manufactured component, and therefore does not guarantee Warranty coverage.

Warranty Resolution

If Balmar authorizes a product to be returned to Balmar or an authorized service provider, Balmar will repair the product or replace it without charge with a functionally equivalent replacement product. Balmar may replace the product with a product that was previously in service or repaired, but re-tested to meet Balmar specifications. Balmar will pay to ship the replacement product to the purchaser. By sending the product for replacement, ownership of the original product will be transferred to Balmar. Labor charges at the consumer's site are not covered under this Warranty. Balmar warrants that repaired or replaced products shall be covered under the Balmar Warranty for the remainder of the original product warranty, or 90 days, whichever is greater.

Not Covered Under Warranty

Balmar's Warranty does not cover any problem that is caused by (a) an accident, abuse, neglect, exposure to shock, electrostatic discharge, heat or humidity beyond the product's specifications, improper installation, inappropriate operation/misapplication, maintenance or modification, or (b) any misuse contrary to the instructions provided with the product, or (c) loss, or (d) malfunctions caused by other equipment, or (e) acts of God. Examples of conditions not warranted: cracked or broken cases, parts damaged by fire, water, freezing, lightning, collision, theft, explosion, rust, corrosion, or items damaged in route to Balmar for repair. Balmar's Warranty is void if a product is returned with removed, damaged or tampered labels or any other alterations (including removal of any component or external cover) to the product. Balmar's Warranty does not cover labor charges or any direct, consequential, or incidental damages. Costs related to recovery removal or installation are not recoverable under the Balmar Limited Warranty.

Applicable Laws

Balmar's Warranty is governed by the laws of the State of Alabama, USA. The Balmar Warranty provides the purchaser specific legal rights, and you may also have other rights that vary from state to state. Balmar's Warranty does not affect any additional rights consumers have under laws in their jurisdictions governing the sale of consumer goods, including, without limitation, national laws implementing EC Directive 44/99/EC. Some states do not allow the exclusion of limitation of incidental or consequential damages, so the limitation or exclusions of Balmar's Warranty may not apply in certain jurisdictions.

Warranty Return Material Process

1. Contact Balmar Technical Support at +1 (360) 435-6100. Tech Support will review the troubleshooting steps with you to help determine if Balmar's product is defective.
2. Go to www.balmar.net and download the RMA request.
3. Once complete, you will receive an RMA number, at which point you should complete the forms and send them with the product and the original receipt showing the date of purchase to Balmar at the address listed below. Please include the RMA number on the outside of the package.
4. Please send the product postage prepaid via a carrier that can track the package. Note: If you have a 9-Series Alternator to return, please ship it to our Marysville, WA location.

Balmar LLC
353 James Record Road SW
Huntsville, AL 35824
Attention: Warranty Returns RMA# _____

Balmar LLC
15201 39th Ave. NE
Marysville, WA 98271
Attention: Warranty Returns RMA# _____

Once Balmar receives the product, we will test the product to determine if the problem is due to a defect in the product. If, at the sole discretion of Balmar, the problem is determined to be a manufacturer defect, Balmar will repair the product or send a new product to replace the defective product.

Balmar will not provide Warranty coverage unless Warranty claims are made in compliance with all the terms listed here, and the specified return procedures are followed.

For more information, contact Balmar Customer Service or Technical Support at +1(360) 435-6100 or visit the Balmar website at www.balmar.net. Balmar LLC believes all information herein to be factual and accurate, yet maintains no liability for factual or typographic error. In addition, Balmar retains the right to revise or update products without notification. Visit the Balmar website for product updates or bulletins and may apply to your alternator or voltage regulator. No part of this document may be reproduced without express written permission of Balmar LLC © Copyright 2017.

Balmar Knows How To Charge Your Batteries



Balmar LLC
15201 39th Avenue NE
Marysville, WA 98271
USA
+1 (360) 435-6100
www.balmar.net

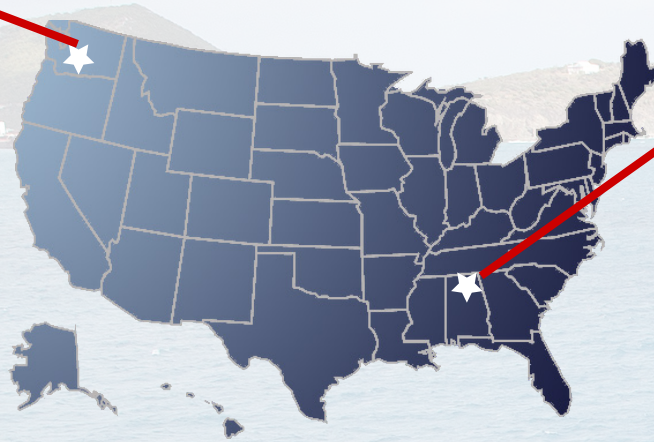

CDI Electronics LLC
353 James Record Road SW
Huntsville, AL 35824
USA
+1 (256) 772-3829
www.cdielelectronics.com



CDI Electronics designs and manufactures ignition components for outboard motors and diagnostic software for most Marine Engines. CDI enjoys relationships with 70 distribution partners around the world. To Find a CDI distribution partner, visit www.cdielelectronics.com.

Both Balmar and CDI Products are manufactured in our ISO 9000-Certified Factory in Huntsville, Alabama.

Please read carefully. All policies, procedures and instructions are subject to change. This guide was prepared to provide information and does not constitute a contract. Balmar reserves the right, without prior notice, to change, delete, supplement, or otherwise amend at any time the information and policies contained in this guide.

For the most recent information about Balmar's products, policies and instructions please visit, www.balmar.net.

© 2017 Balmar LLC

